

Digital Meets Analog.

# Table of Contents

---

This manual covers Data Bender firmware v1.4.5

Foreword	<a href="#">1</a>
Description	<a href="#">2</a>
Module Installation	<a href="#">2</a>
What Is Circuit Bending?	<a href="#">3</a>
Recommend Reading	<a href="#">3</a>
Front Panel Diagram	<a href="#">4</a>
Functions	
• Time	<a href="#">5</a>
◦ Internal Clock Mode	<a href="#">5</a>
◦ External Clock Mode	<a href="#">5</a>
• Repeats	<a href="#">6</a>
• Mix	<a href="#">6</a>
• Mode	<a href="#">7</a>
• Macro Mode	<a href="#">7</a>
◦ Bend	<a href="#">7</a>
◦ Break	<a href="#">8</a>
• Micro Mode	<a href="#">9</a>
◦ Bend - Playback Speed/Reverse	<a href="#">9</a>
◦ Break - Traverse/Silence	<a href="#">10</a>
• Corrupt	<a href="#">11</a>
• Freeze	<a href="#">12</a>
• Clock	<a href="#">12</a>
• Shift	<a href="#">13</a>
◦ Shift+Time: Glitch Windowing	<a href="#">13</a>
◦ Shift+Repeats: LED Dimmer	<a href="#">13</a>
◦ Shift+Mix: Stereo Enhancement	<a href="#">14</a>
◦ Shift+Bend Knob: Bend CV Attenuator	<a href="#">14</a>
◦ Shift+Break Knob: Break CV Attenuator	<a href="#">14</a>
◦ Shift+Corrupt Knob: Corrupt CV Attenuator	<a href="#">14</a>
◦ Shift+Bend Button: Stereo Behavior	<a href="#">14</a>
◦ Shift+Break Button: Restore Default Settings	<a href="#">15</a>
◦ Shift+Corrupt Button: Corrupt As Buffer Reset	<a href="#">15</a>
◦ Shift+Freeze Button: Freeze Behavior	<a href="#">15</a>
◦ Shift+Clock Button: Gate Behaviors	<a href="#">16</a>
◦ Shift+Mode Button: Corrupt Offerings	<a href="#">16</a>
Store Settings Between Power Cycles	<a href="#">16</a>
Audio IO	<a href="#">17</a>
Calibration	<a href="#">17</a>
Updating Firmware/Firmware Version Check	<a href="#">18</a>
Patch Examples	<a href="#">19</a>
Warranty	<a href="#">22</a>
Changelog	<a href="#">23</a>

# Foreword

---

TL;DR: If it ain't broke, don't fix it.

Perhaps one of the greatest things about electronic music is how it changes the way that we listen to the world. The distinction between music and noise becomes blurry and often disappears altogether. This was my experience at least, and it quickly allowed me to find music everywhere around me. Drumbeats from the dishwasher, drones from the A/C unit - there were few sounds that could not be placed in a music context.

Another unintended consequence was that the delineation between functioning and non-functioning audio equipment became unimportant. Sometimes I preferred when my CDs were scratched, my cell phone was slightly too far from a Bluetooth speaker, or when a children's toy was running out of battery. Composer Kim Cascone summarizes this phenomena in his essay, *The Aesthetics of Failure*, "The technique of exposing the minutiae of DSP errors and artifacts for their own sonic value has helped further blur the boundaries of what is to be considered music, but it has also forced us to examine our preconceptions of failure and detritus more carefully."

And what group has better harnessed this new aesthetic of failure than circuit benders? Armed with solder, jumper wires, and serendipity, these people hunt for the most effective way to make audio devices misbehave.

As a longtime fan of circuit bending, I've always wanted to bring that sense of discovery to the digital realm. What if we had digital "bend points", that were attached to knobs and switches, affecting how DSP was rendered, all under voltage control? This was the inspiration for Data Bender.

I hope you have as much fun breaking it as we did.

Happy patching,

Andrew Ikenberry  
Founder & CEO



*Andrew and his circuit-bent  
Speak N' Spell*

## Description

---

Data Bender is a circuit bent digital audio buffer. It is inspired by the ways in which audio equipment can fail. The sounds of skipping CDs, software bugs, and defective tape machine playback are all accessible. The 96kHz, 24-bit audio buffer can hold over a minute of stereo audio, providing a sonic canvas capable of infinite surprises and discovery.

- Circuit bent digital audio buffer
- Skipping CDs, software bugs, old tape machine, scratched records
- 96kHz sample rate, 24-bit depth for high fidelity audio with over a minute of stereo sampling time
- Stereo IO

### Tech Specs

Width: 14HP

Depth: 28mm

Power Consumption: +12V=58mA, -12V=60mA, +5V=0mA

## Module Installation

---

To install, locate 14HP of space in your Eurorack case and confirm the positive 12 volts and negative 12 volts sides of the power distribution lines.

Plug the connector into your case's power supply unit, keeping in mind that the red band corresponds to negative 12 volts. In most systems, the negative 12 volt supply line is at the bottom.

The power cable should be connected to the module with the red band facing the bottom of the module.

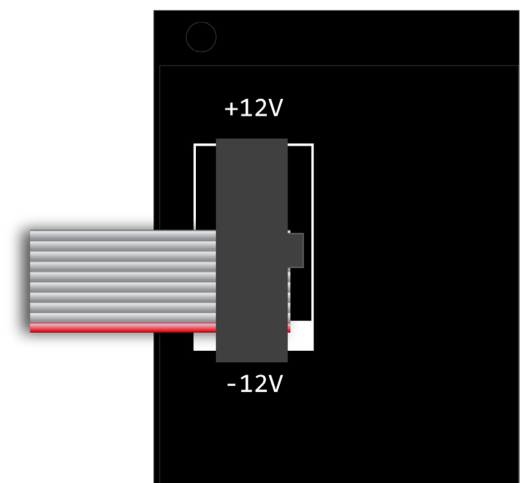

# What Is Circuit Bending?

---

Circuit bending is the manipulation of existing electronic circuits to achieve unpredictable and exciting results. The technique was pioneered by Reed Ghazala in the 1960s and has garnered a cult following in the world of electronic music.

In practice, circuit bending usually involves finding two points on a circuit board which, when connected, will cause the device to operate in a different manner than originally intended. For example, if you create short circuits between the data lines of a digital instrument, the audio output will become jumbled.

Certain devices lend themselves especially well to circuit bending and have accumulated a standard set of documented bend points. These include the [Casio SK-1](#), [Furby](#), and of course, the Texas Instruments [Speak and Spell](#) series.



Reed Ghazala

## Recommended Reading

---

Cage, J., 1961. *Silence*. Middletown, Conn.: Wesleyan University Press.

Cascone, K. (2000). *The Aesthetics of Failure: "Post-Digital" Tendencies in Contemporary Computer Music*. *Computer Music Journal*, 24(4), 12-18.

Ghazala, Reed. *Circuit-Bending Build Your Own Alien Instruments*. Wiley Publishing, 2005.

Russolo, L. (2009). *The Art of Noises: A Futurist Manifesto (1913)*. In L. Rainey, C. Poggi, & L. Wittman (Eds.), *Futurism: An Anthology* (pp. 133-139). Yale University Press.

# Front Panel

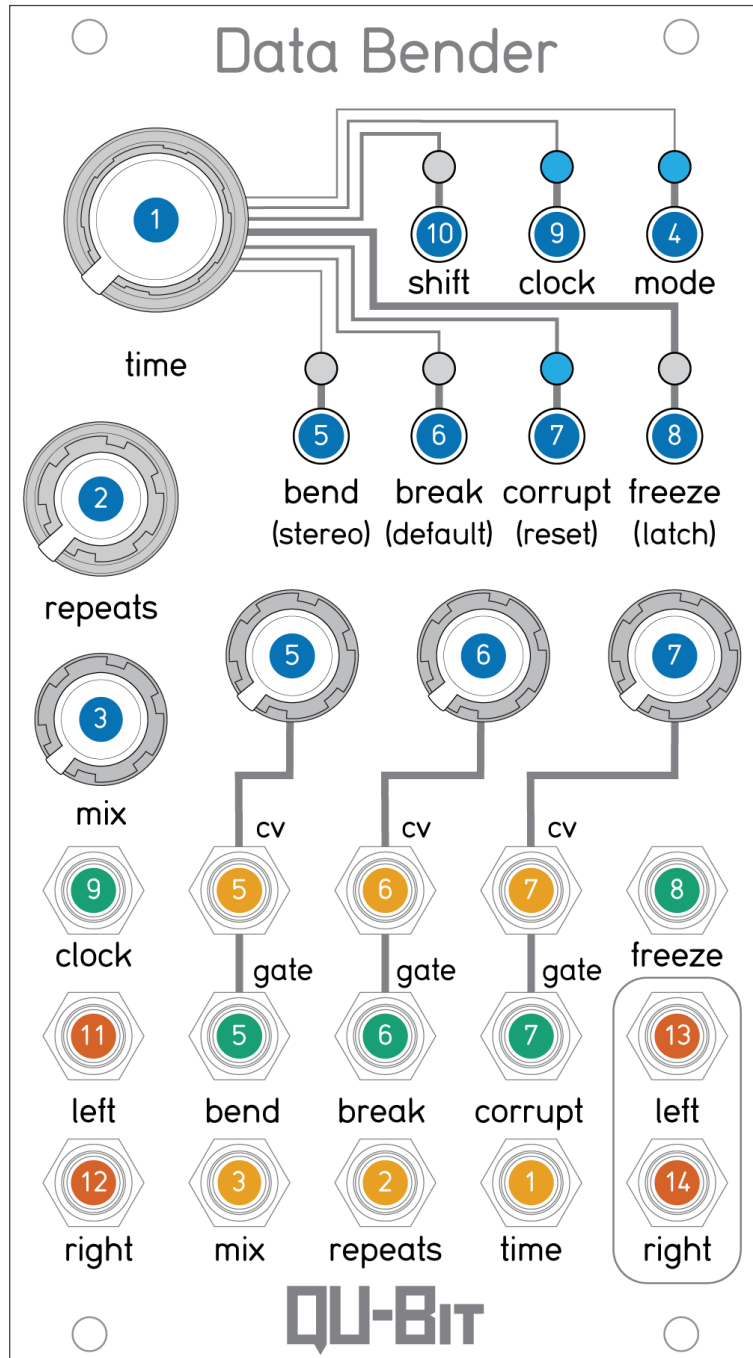

● Tactile Controls   
 ● CV Inputs   
 ● Gate Inputs   
 ● Audio IO

# Functions - Persistent Between Modes

## 1. Time

- Time sets the sample period for incoming audio to be processed. This is the rate at which a new audio buffer is acquired for processing and manipulation. Switch between Internal and External Clock modes by pressing the Clock button.

The buffer space located outside of the current section set by time is written to in the background so that some fairly recent audio is always in the buffer when time is changed. This can bring back sounds from up to a minute ago in unexpected and interesting ways.

- Time CV Input Range: -5V to +5V from the knob position.

### Internal Clock Mode

In this mode the clock LED will blink blue at the clock rate. The Time knob will be a smooth changing value from **16 seconds** at the bottom of the knob to **80Hz** at the top of the knob.

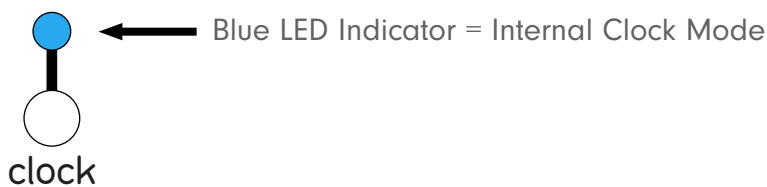

### External Clock Mode

In this mode the clock LED will blink white at the clock rate.

The Time Knob acts as a divide/multiply control with the following changes to the clock:

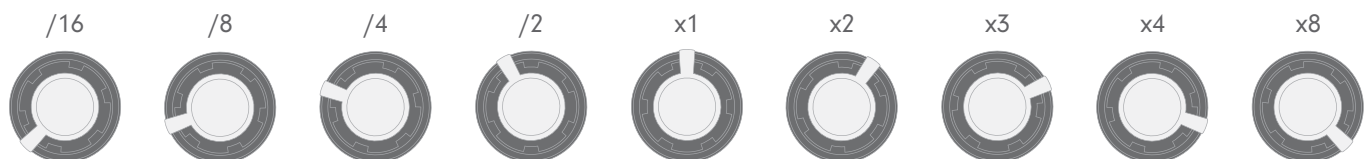

When the knob/CV move into a new division or multiplication, the Clock LED will briefly illuminate gold.

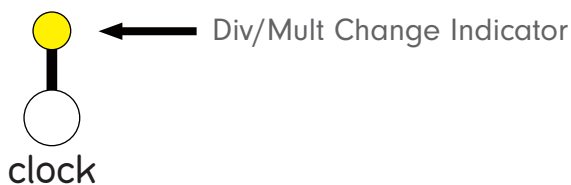
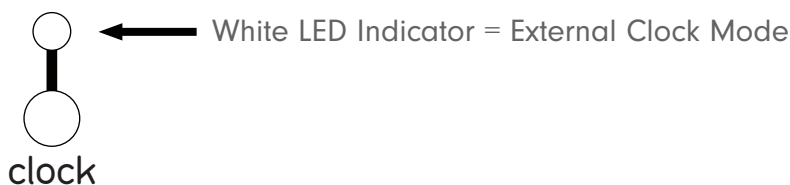

# Functions - Persistent Between Modes

---

## 2. Repeats

- Repeats divides the primary buffer into smaller subsections of audio. These will be heard as repeated pieces of the recorded audio buffer. The higher the knob is increased the more divisions of the buffer are created, and the “faster” the apparent audio will come out. With the control all the way down the primary buffer will not be subdivided.

Several parameters within the module will control which section of the buffer is repeating as well as modify this control itself.

- Repeats CV Input Range: -5V to +5V from the knob position.

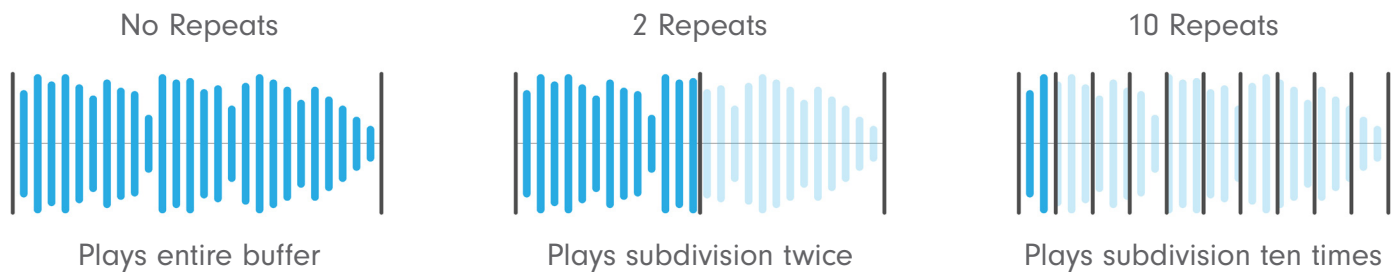

*Experiment:* Repeats is the quickest way to create controlled stutter effects with Data Bender. While in external clock mode, send clocked CV to the Repeats CV input for instant stutters. Perfect for creating vocal glitches, or percussive beat repeats at the end of a bar for glitch transitions.

Go further by turning the Time knob to hear the effect on Repeats, and turning both up can bring the subdivisions to audio rate, turning your buffer into it's own unique sound source!

## 3. Mix

- This controls the balance between the live input, and the audio buffer being processed. When the knob is fully CCW, only the dry signal is present. When the knob is fully CW, only the wet signal is present.
- Mix CV Input Range: -5V to +5V from the knob position.



# Functions - Different Between Modes

---

## 4. Mode

- The next two functions, Bend and Break, vary functionality between modes, which is determined by the Mode button.

Pressing the Mode button selects between Macro Mode (Blue LED) and Micro Mode (Green LED). These modes are described below, and change the way Bend and Break work. The rest of Data Bender's functions are persistent between modes.

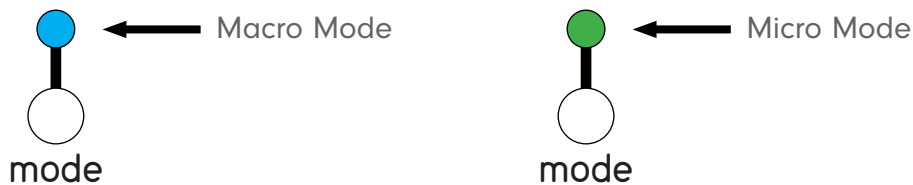

## Macro Mode

---

Macro mode is a set of 2 controls (Bend and Break) that have automated parameters based on the clock settings. Macro Mode is indicated by a Blue Mode LED.

Set the knobs where you like them and let the Data Bender bend your data for you.

## 5. Bend

- Bend provides manipulations that are inspired by the tape medium and its associated playback machines. With this control you can experience the following effects:
  - Vari-speed pitch changes
  - Reversed audio playback
  - Vinyl clicks and pops
  - Tape stop

Enabling/Disabling bend using the Gate or Button will toggle this control on or off. When enabled (LED Blue), every clock division a certain manipulation of the playback speed and direction can occur. When the knob is all the way down, the effect is disabled.

At the lowest settings, it will only have a slight chance to reverse the audio at the normal playback speed. At the maximum settings, it can play back the audio forward or backward at various intervals, and will begin to introduce a slew to the changes in playback speeds.

- Bend CV Input Range: -5V to +5V from the knob position
- Bend Gate Input Threshold: 0.4V

# Functions - Different Between Modes

## 6. Break

● Break emulates the malfunctioning of digital audio devices such as CDs, wireless audio, and software bugs. With this control you can experience the following effects:

- Glitches and stutters similar to a scratched CD
- Disjointed playhead movement
- Synchronized Audio dropouts

Enabling/Disabling Break using the Gate or Button will toggle this control on or off. When enabled (LED Blue), every clock division a certain manipulation of the number of repeats and playback position may occur. When the knob is all the way down, the effect is disabled.

At the lowest settings, it will only have a slight chance to add additional repeats, or move to a new sub-section of the buffer. At the maximum settings, it can jump to any sub-section of the buffer, and has a high likelihood to do so. It can also set the repeats to anywhere above where the knob is set, and add up to 90% silence to each repeat.

● Break CV Input Range: -5V to +5V from the knob position

● Break Gate Input Threshold: 0.4V

## Bend And Break Knob Zones

Though both Bend and Break are automated in Macro Mode, there are specific sections on the knob that can provide specific variations to the buffer.

Note that, as you go across the knob, each variation is added to the ones before it, increasing the overall number of possible variations to the buffer. See the graphics below for the different Bend and Break variations:

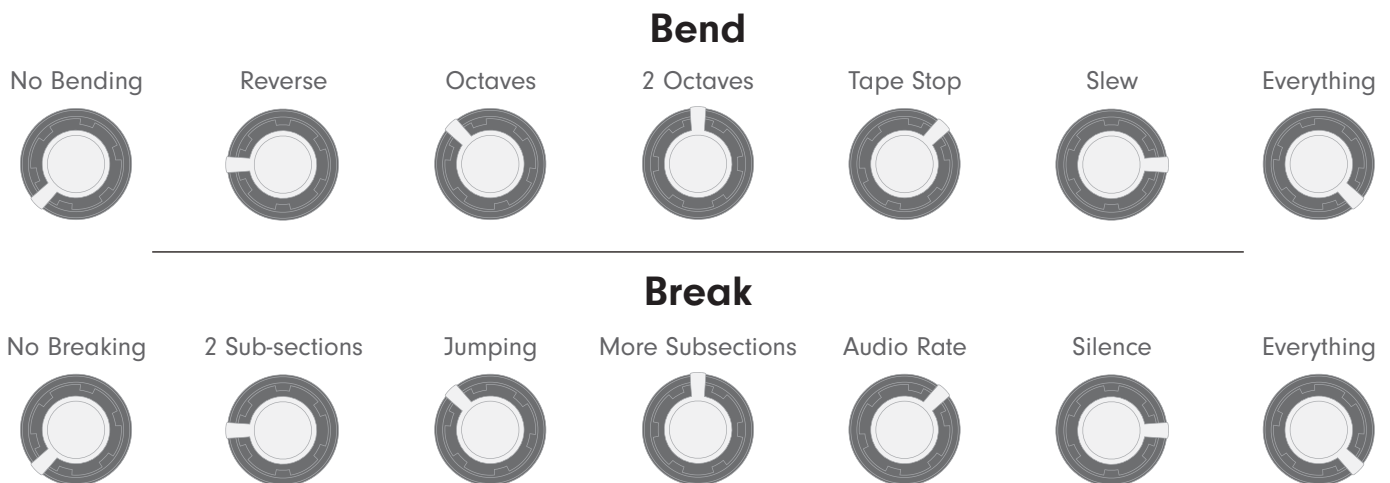

Note: Break's knob variations are dependent on the Time and Repeats settings, as well as the internal or external clock.

# Functions - Different Between Modes

## Micro Mode

Take control of the microcosms of destruction and failure with discrete controls for the module's parameters. Micro Mode is indicated by a Green Mode LED.

Though Macro Mode provides immediacy for those data bending cravings, Micro Mode gives you complete control over any manipulation of the buffer, letting you break out of the "Data Bender" sound mold.

### 5. Bend

- This control acts as playback speed going down 3 octaves and up 3 octaves, and tracks 1V/Oct.

When the playback speed is forward the LED will be blue, unless it is on a specific multiple (octave) above or below the original playback speed. Then it will be cyan.

When reversing, the LED will be green unless it is on a specific multiple above or below the playback speed, then the LED will be gold. Pressing Bend will toggle the playback to reverse.

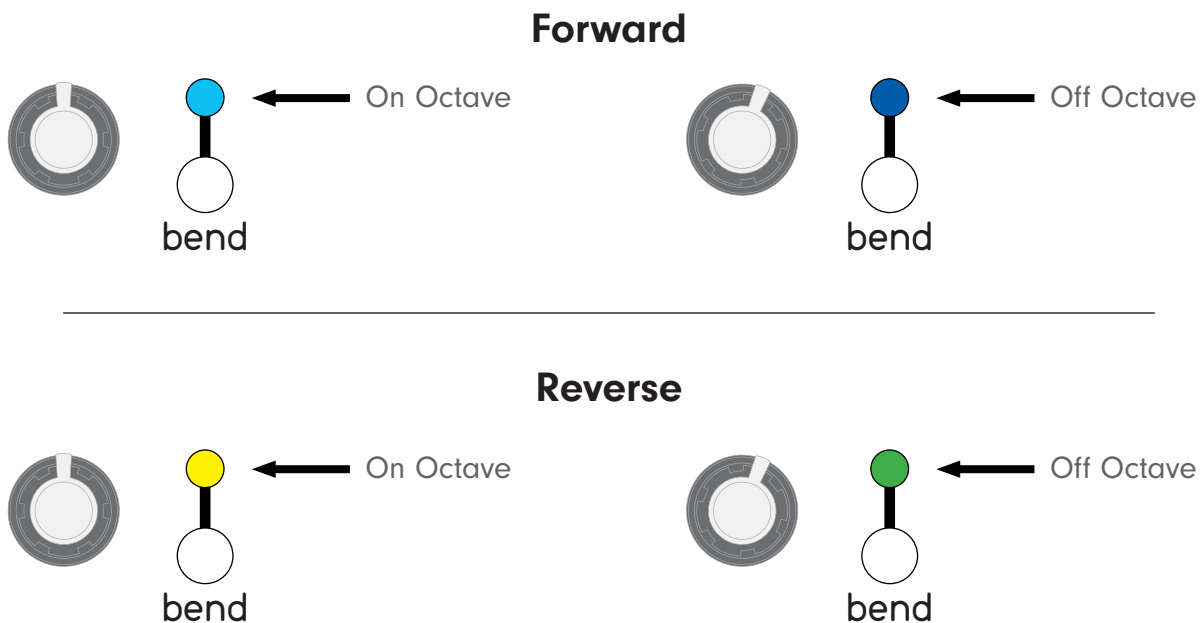

- Bend CV Input Range: -5V to +5V from the knob position. Tracks 1V/Oct. See how to calibrate your Data Bender for 1V/Oct here.
- Bend Gate Input: Toggles between forward and reverse playback. Threshold: 0.4V

# Functions - Different Between Modes

## 6. Break

- Pressing the button or using a Gate will toggle between Traverse and Silence. When either the knob, CV or the Repeats setting changes the currently selected subsection, the Break LED will blip gold.

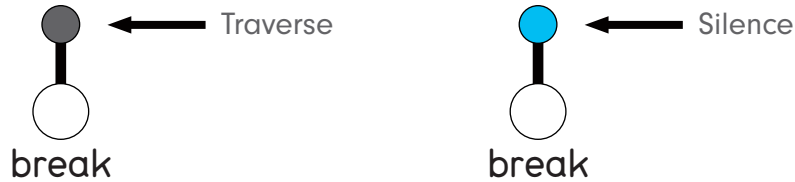

### Traverse

When the LED is not illuminated the break controls subsection traversal, allowing you to select from each chunk of the active buffer. On the far left of the knob, the first subsection will be selected. On the far right of the knob, the last subsection (determined by Repeats) will be selected.

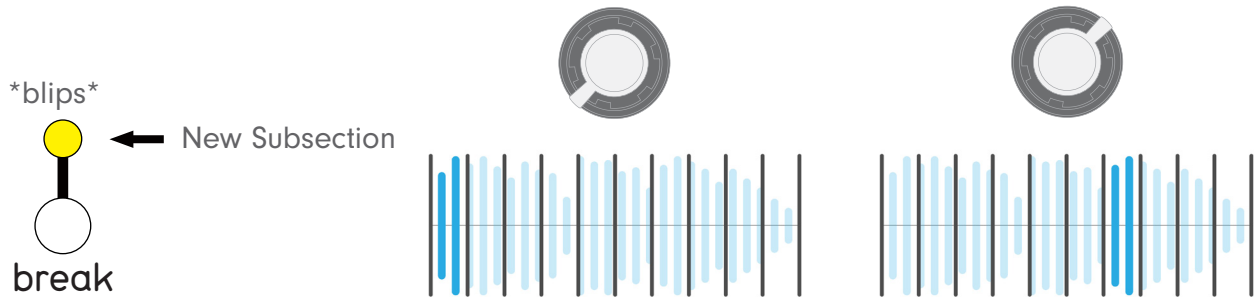

When Repeats is set to 1 (all the way left), this will have no effect.

### Silence

When the LED is illuminated Blue, the control acts as a duty-cycle for the amount of silence introduced.

On the far left of the knob, there will be no silence. On the far right of the knob, 90% of the playback buffer will be replaced with silence.

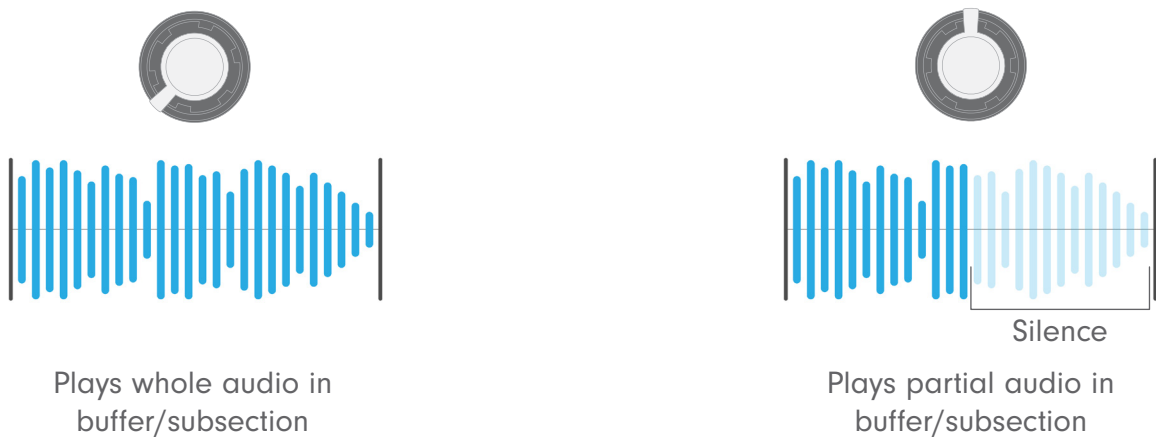

- Break CV Input Range: -5V to +5V from the knob position.
- Break Gate Input: Toggles between Traverse and Silence. Threshold: 0.4V

# Functions - Persistent Between Modes

---

## 7. Corrupt

- Corrupt is an interchangeable end-of-chain effect within Data Bender, and includes 5 audio degrading style effects. The knob controls a variable range for each control, and the button cycles between the 5 effects.

Corrupt is off when the knob is fully CCW and/or when  $\leq 0V$  is present at the CV input.

- Corrupt CV Input Range: -5V to +5V from the knob position.
- Corrupt Gate Input: Advances to the next Corrupt effect when gate signal is high. Threshold: 0.4V

### Corrupt Effects

#### Decimate | LED Color: Blue ●

Controls variable amounts of bit crushing and down sampling to the buffer. Unlike a more traditional, linear change across the knob, Decimate is a collection of fixed variations in random order, from subtle white noise hiss to heavily distorted blown out speakers.

#### Dropout | LED Color: Green ●

Controls the occurrence of random audio dropouts. There are less, but longer dropouts on the left side of the knob, and more, but shorter dropouts on the right side of the knob.

#### Destroy | LED Color: Gold ●

Controls an amount of Soft saturation and hard clipping applied to the signal. The first half of the knob softly saturates, and the second half introduces absolute devastation.

**Caution:** this gets loud if using with signals that aren't modular level to begin with!

#### DJ Filter | LED Color: Purple ●

Controls a moderately resonant DJ-style filter applied to the buffer. No filtering occurs when Corrupt is at 12 o'clock, low pass filters below 12 o'clock, and high pass filters above 12 o'clock.

#### Vinyl Sim | LED Color: Orange ●

Controls a vinyl simulation effect on the buffer. When the knob is fully CCW, no vinyl effect is present. As the knob is turned CW, dust, pops, and subtle coloring are introduced. When the knob is fully CW, Data Bender turns into a 100 year old turntable.

# Functions - Persistent Between Modes

## 8. Freeze

- When enabled, no new audio will be recorded into the audio buffer, and whatever is there will stay there until Freeze is deactivated.

Extending the time control down below where it was when the signal was frozen will introduce artifacts of old data from the last time the buffer was that size. Expect discontinuities, and fragments of your sonic history when twisting the time knob while frozen.

*Quick Tip:* When the Mix control is fully dry, engaging freeze will instantly set the mix to be fully wet. This allows for exciting performative gestures, and the queuing up of specific data bending actions, while letting the rest of your audio pass through unaffected until freeze is enabled. All changes to Time, Repeats, Bend, and Break are not destructive. So feel free to mangle away without fear of losing your precious buffer.

To learn more about Momentary and Latching Freeze Modes, head to the Shift Menu section.

- Freeze Gate Input Threshold: 0.4V

## 9. Clock

- Toggles between internal and external clock modes. While the module is in internal clock mode the LED will blink blue at the rate of the internal clock.

When in external clock mode, the clock input will be used as the source for the Time control, and the Time Knob/CV will control the divisions/multiplications of the clock that new audio will be recorded at. This is indicated with a white blinking LED, which will match the div/mult rate set by Time.



If the module has not received an external clock for at least four beats (one measure) at the last recorded clock rate, the LED will illuminate a DIM white to indicate that there is no clock source present.

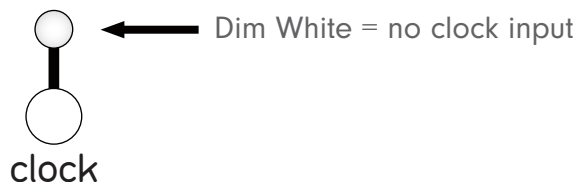

While there is no clock source, the clock will continue to run at the last rate until a new clock pulse is detected.

- Clock Input Threshold: 0.4V

# Functions - Persistent Between Modes

---

## 10. Shift

- Used for Secondary functions, and additional features. When held, Data Bender grants access to the available edit functions found across the front panel.

Edit functions are labeled as “Shift+N” in the manual, which means you must hold shift, and either turn the respective knob or press the respective button to perform the edit. Releasing Shift will exit the edit mode. Though a knob may be in a different position than where it was pre-edit, Data Bender will still behave as if the knob was in it’s original position until the knob is turned, or CV is sent to the respective input.

### Shift+Time: Glitch Windowing

While holding Shift and turning the Time knob, you can scale an amount of windowing to be applied to the individual stutters. When turning this all the way down there will be hard edges, and clicks will happen often, which is great for glitch beats and sound effects!

When turning this all the way up, the glitches will be fully windowed, only reaching its full volume for a moment before fading back out, which is ideal for ambient jamz.



While holding SHIFT, the shift LED will indicate the current amount of windowing.

- If the LED is off then there is no windowing applied.
- If the LED is blue, then the default minimal amount of windowing is applied.
- Beyond that, the LED will indicate from dim to bright white the amount of windowing applied.

The Restore Settings action below will reset this to the default amount of windowing.

### Shift+Repeats: LED Dimmer

Holding Shift and turning the Repeats knob will adjust the LED brightness level on Data Bender. This is useful for adjusting brightness depending on your ambient lighting situation, whether you are in a dark studio or the great outdoors!

When the knob is fully CCW, the minimum LED brightness occurs. When the knob is fully CW, the maximum LED brightness occurs.

# Functions - Persistent Between Modes

---

## Shift+Mix: Stereo Enhancement

Hold Shift and turning Mix to adjust Data Bender's stereo imaging. When the knob is fully CCW, stereo enhancement for the buffer is at a minimum. When the knob is fully CW, The buffer's left and right channels are pushed to the very edge, creating a wide stereo field.

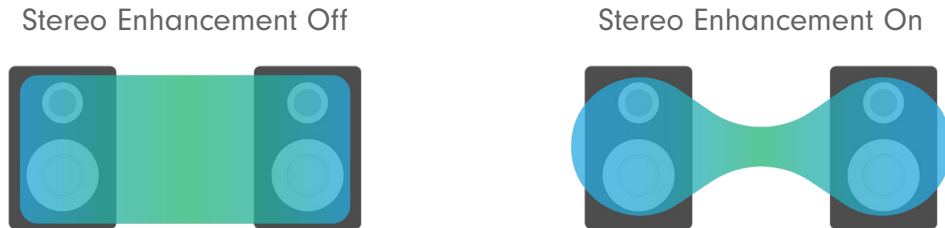

## Shift+Bend Knob: Bend CV Attenuator

Holding Shift and turning the Bend knob will set the attenuation on the Bend CV input. When the knob is fully CCW, maximum attenuation occurs at the Bend CV input and let's no CV through. When the knob is fully CW, no attenuation occurs.

Does not attenuate in Micro Mode, since the CV Input tracks 1V/oct.

## Shift+Break Knob: Break CV Attenuator

Holding Shift and turning the Break knob will set the attenuation on the Break CV input. When the knob is fully CCW, maximum attenuation occurs at the Break CV input and let's no CV through. When the knob is fully CW, no attenuation occurs.

## Shift+Corrupt Knob: Corrupt CV Attenuator

Holding Shift and turning the Corrupt knob will set the attenuation on the Corrupt CV input. When the knob is fully CCW, maximum attenuation occurs at the Corrupt CV input and let's no CV through. When the knob is fully CW, no attenuation occurs.

## Shift+Bend Button: Stereo Behavior

While holding shift, the Bend LED will indicate the stereo behavior of the macro-mode controls. Pressing the Bend button will toggle between these modes:

- Blue - **Unique Mode**: All automatic bend/break settings will be unique for each stereo channel.
- Green - **Shared Mode**: All automatic bend/break settings are set the same for both stereo channels.



### Shift+Break Button: Restore Default Settings

While holding shift, pressing the Break button will restore all settings back to their defaults. The LED for this button will pulsate white to indicate that it is the restore default settings function. When pressed it will blink blue to indicate the settings have been restored to their defaults.

This sets:

- Windowing back to default windowing (2%)
- Bend off
- Break off
- Freeze off
- Mode to Macro Mode
- Stereo behavior to Unique Mode.
- Gates to Latching
- Break Jack set to primary function (not reset/sync).
- Freeze button behavior to Latching Mode

### Shift+Corrupt Button: Corrupt As Buffer Reset

While holding shift the corrupt LED will indicate whether the corrupt Gate input jack is configured as normal (blue), or as a reset input (green).

When configured as a reset jack, the corrupt input will cause the internal or external clock to re-sync. This can be useful for synchronizing with a DAW or manually restarting the buffer, and randomizing Macro Mode controls when running with a slow internal clock.

In internal clock mode, this will re-sync the internal clock immediately, causing new audio to load into the buffer, possibly resulting in silence during certain bend/break settings. This does move the playback heads into a reset position immediately which can cause clicks.

In external clock mode, this resets the subdivision counter to align the divided clock with an external beat. This will take effect on the next clock pulse.

### Shift+Freeze Button: Freeze Behavior

While holding shift, the Freeze LED will indicate the behavior of the Freeze Button. Pressing the Freeze button while holding shift will toggle between these modes:

- Blue - Freeze button is **latching**, releasing the button will toggle the state between frozen and unfrozen, on the next clock cycle.
- Green - Freezes button is **momentary**, pressing the button engages freeze instantly, releasing the button disengages.

# Functions - Persistent Between Modes

## Shift+Clock Button: Gate Behaviors

While holding shift, the Clock LED will indicate whether the gates are configured as momentary or latching.

Pressing the button while holding shift will toggle between the two options:

- When the LED is blue the gates are **latching** (each trigger input will toggle the state of the gated controls).
- When the LED is green the gates are **momentary** (an incoming gate signal will hold the state of the button on if it is off, as long as it is held high).

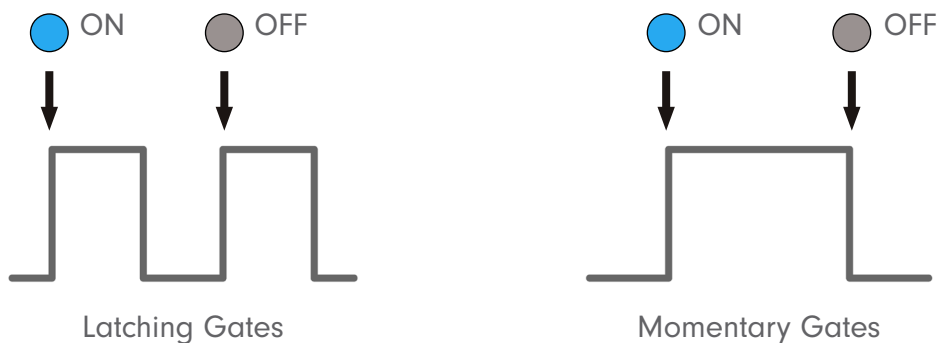

## Shift+Mode Button: Corrupt Offerings

Holding Shift and pressing Mode will swap between the current Data Bender Corrupt effect offerings and the original offerings.

- When the Mode LED is blue, all 5 effects on Corrupt are available.
- When the Mode LED is green, only the original 3 effects on Corrupt are available, Decimate, Dropout, and Destroy.

## Storing Settings Between Power Cycles

Several Settings are stored between power cycles. Settings are stored whenever the Shift button is released, as frequently as once every two seconds.

The following settings are stored:

- Bend state
- Break state
- Corrupt Mode
- Clock source
- Processor Mode (Micro, Macro)
- Stereo Mode (Unique, Shared)
- Windowing amount
- Latching/Momentary gate behavior
- Latching/Momentary freeze button behavior
- Corrupt as Reset behavior

## Functions - Persistent Between Modes

---

### 11. Audio Input Left

- Audio input for Data Bender's left channel. The left input normals to both channels when no cable is present in Audio input Right.

Input Range: 10Vpp AC-Coupled

### 12. Audio Input Right

- Audio input for Data Bender's right channel.

Input Range: 10Vpp AC-Coupled

### 13. Audio Output Left

- Audio output for Data Bender's left channel.

Input Range: 10Vpp

### 14. Audio Output Right

- Audio output for Data Bender's right channel.

Input Range: 10Vpp

## Calibration

---

If your Data Bender was purchased new is on the most recent firmware from the factory, then your module has already been precisely calibrated to track 1V/Oct on Bend in Micro Mode. If you are either:

- Unsure if your Data Bender is calibrated due to it being used.
- Updating your Data Bender to the most recent firmware.
- Looking to recalibrate your Data Bender

Then you can follow the steps below to calibrate your module.

1. Hold down Mode, and boot up Data Bender. Hold the button down until the Bend LED is red and the Break LED is white.
2. With no other CV/Gate inputs present in the module, patch in 1V (1 octave up from root on your sequencer) to the Bend CV input.
3. Press Bend. The LED above Bend will now illuminate Gold.
4. Patch 3V (3 octaves up from root on your sequencer) into the Bend CV input.
5. Press Bend. The LED above Bend will now illuminate Green.
6. To save and exit calibration mode, press Shift. Your Data Bender is now calibrate and in normal operating mode.
7. To restore the factory calibration, press the Break button at any point during the calibration mode, then press Shift to save and exit calibration.

# Updating Your Data Bender

---

To grab the latest firmware for Data Bender, head on over to the product page! Then, either follow the steps below, or follow along with our video tutorial.

If your Data Bender is on the most recent firmware (v1.4.5), then you do not need to reflash your module. See the firmware version check section below to determine your Data Bender's firmware, and then follow these instructions to update:

1. In a Chrome browser window, navigate to the [Electrosmith Web Programmer](#).
2. Once there, connect the Daisy Seed, the yellow/black backpack on your Qu-Bit module, to your computer using a micro USB cable. (Windows Users: you may have to reset your USB driver before proceeding. See the [Zadig wiki page](#) for full instructions.)
3. Make sure your module is plugged in and powered via its eurorack power cable.
4. Put your module into flashable mode by holding down the BOOT button, and pressing the RESET button. Once you release the RESET button you can let go of the BOOT button.
5. Connect the module as a DFU device by clicking the "Connect" button at the top of the Web Programmer page.
6. In the dialog box that opens, select "DFU in FS Mode" and then click "Connect."
7. Download, unzip, and drag the firmware file (.bin) into the File Window on the Web Programmer page.
8. Press program to update the firmware. You will be notified once the module is up to date!

## Firmware Version Check

---

Firmware versions are indicated via the top 3 LEDs on Data Bender at boot up. The color assignment is as such:

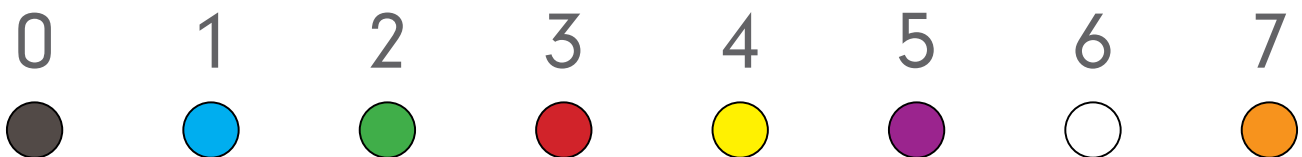

The latest version, v1.4.5, then will show the below color scheme on boot up:

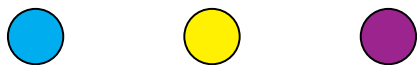

All versions of Data Bender prior to v1.4.5 do not follow the firmware color scheme, and will boot up as such:



# Patch Examples

## Lo-Fi Tape Machine

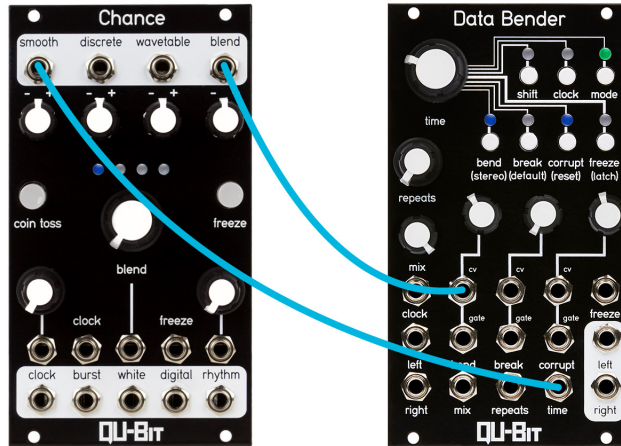

Turn your Data Bender into a lo-fi tape machine with control over pitch & tape speed, pops, noise and audio dropouts.

Modules: Data Bender, Modulation Source (Qu-Bit Chance)

Data Bender Settings:

- Mode: Micro
- Mix: 100%
- Time: 30%
- Repeats: 0%
- Bend: ~45%
- Corrupt: ~45%
- Glitch Windowing (SHIFT-TIME): 0%

In Micro Mode, Bend acts as a live pitch and speed manipulator, with the option of reversing the buffer. Corrupt adds subtle white noise, audio dropouts, or tape saturation depending on your mode preference. By sending CV into the Bend CV IN and TIME IN, variations in pitch, speed, and tape pops lend to an organic tape experience.

# Patch Examples

## CD Skip

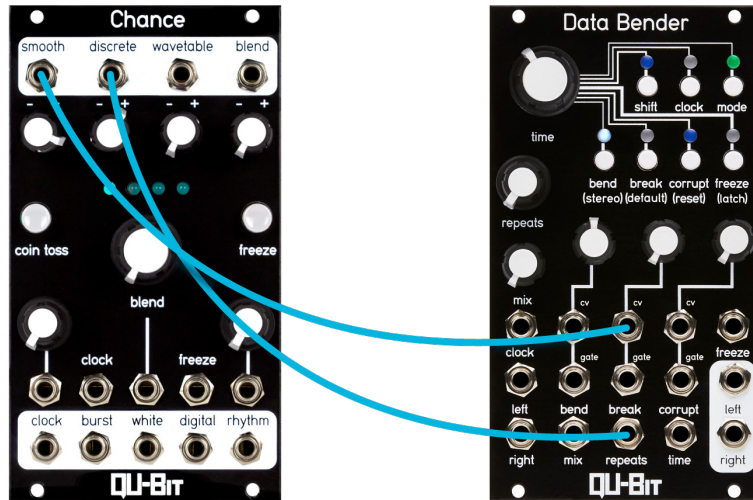

Bring back the nostalgia of early 2000's road trips using Data Bender's discrete buffer control.

Modules: Data Bender, Modulation Source (Chance), Clock Source (if desired)

Data Bender Settings:

- Mode: Micro
- Mix: 100%
- Time: 30%
- Repeats: 0%
- Break: 0%
- Break Mode: Traverse (LED off)
- Glitch Windowing (SHIFT-TIME): 0%

In Traverse Mode, Break divides the buffer into subsections whose amount is determined by the Repeats knob. The higher the repeats, the more subsections.

By sending modulation to Repeats moving the parameter from no subsections to 2 or more, break is able to sweep through the subsections. This emulates the skipping of a song due to a CD scratch. Using a Clock source to sync the scratches can turn the skip into a circular skip emulation, bringing out the best and worst of listening to old CD's.

# Patch Examples

## Ghost In The Machine

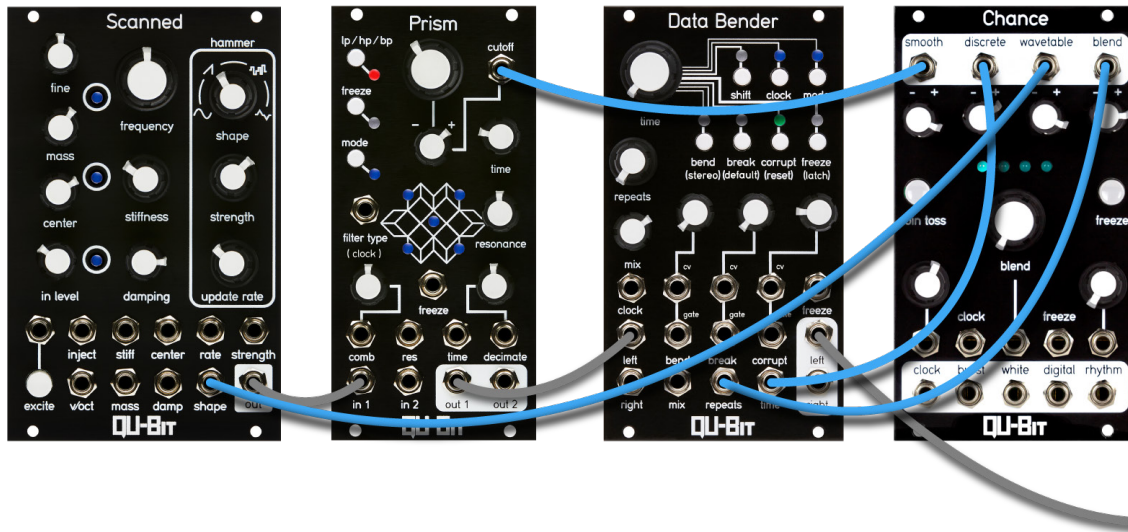

I'm sorry Dave, I'm afraid I can't patch that.

Modules: Data Bender, Sound Source (Scanned, Prism), Modulation (Chance)

Data Bender Settings:

- Mode: Macro
- Mix: ~75%
- Time: 0%
- Repeats: 0%
- Clock: Internal
- Corrupt Mode: Dropout
- Corrupt: ~25%

The main voice is built with Scanned, our organic wavetable VCO, and Prism. Scanned provides the complex oscillation while Prism dials in the vocoder-esque timbres with the bandpass filter and decimator. This patch is all about chaos, for which Data Bender's Macro Mode is perfect. CV is sent from Chance to Data Bender's TIME and REPEATS CV inputs. Mix is brought up to introduce "unwanted glitches" and audio cuts using Corrupt's Dropout Mode.

To get even more out of this patch, sending random CV to Scanned's v/oct brings the ghost out even more, or Mult Chance's outputs to all of Data Bender's CV and GATE inputs for a complete takeover!

## Qu-Bit Lifetime Repair Warranty

---

No matter how long you've owned your module, or how many people have owned it before you, our doors are open to any and all Qu-Bit modules needing repair. Regardless of circumstances, we will continue to provide physical support for our modules, with all repairs being completely free of charge.\*

[Learn more about the lifetime repair warranty.](#)

\*Issues that are excluded from the warranty, but do not void it includes scratches, dents, and any other user-created cosmetic damage. Qu-Bit Electronix holds the right to void warranty at their own discretion and at any time. Module warranty may be voided if any user damage is present on the module. This includes, but is not limited to, heat damage, liquid damage, smoke damage, and any other user-created critical damage on the module.



# Changelog

---

Firmware Version	Notes
v1.1.0	<ul style="list-style-type: none"><li>• Release Firmware</li></ul>
v1.4.4	<ul style="list-style-type: none"><li>• Added 1v/oct calibration to Micro Mode Bend CV input.</li><li>• Added LED Dimmer via Shift+Repeats.</li><li>• Added adjustable stereo width via Shift+Mix.</li><li>• Added CV attenuators for Bend (Shift+Bend knob), Break (Shift+Break knob), and Corrupt (Shift+Corrupt knob) CV inputs.</li><li>• Added DJ Filter Corrupt effect.</li><li>• Added Vinyl Simulator Corrupt effect.</li><li>• Added Corrupt offerings toggle via Shift+Mode.</li><li>• Fixed dry signal bleed issue when Data Bender is fully wet.</li><li>• Fixed Micro Bend knob range issue and LEDs, is now able to reach the 3rd octave via knob input.</li><li>• Added default windowing Blue LED blip on knob range.</li></ul>
v1.4.5	<ul style="list-style-type: none"><li>• Fixed issue with switching between Micro Mode and Macro Mode where Micro Pitch would affect Macro Mode.</li><li>• Fixed issue with Bend and Break switches across Macro and Micro modes (Bend/Break switches would toggle Micro's reverse when in Macro and vice versa).</li><li>• Bend and Break now save separate states for Micro and Macro Mode.</li><li>• Added new firmware LED color indicators: 5=purple, 6=white, 7=orange.</li></ul>